

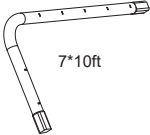

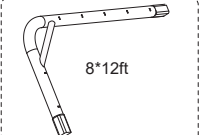

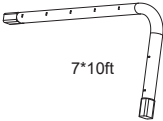
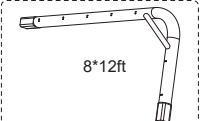
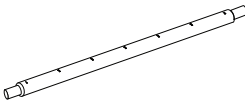
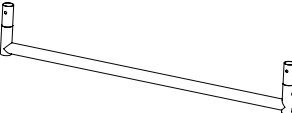
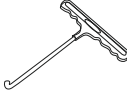

**Assembly / Montage / Montage / L'assemblage/samling**

| PART NO |                                                                                                                                                                                   | QTY                        |
|---------|-----------------------------------------------------------------------------------------------------------------------------------------------------------------------------------|----------------------------|
| 1       |  7*10ft  8*12ft | 2                          |
| 2       |  7*10ft  8*12ft | 2                          |
| 3       |                                                                                                 | 4                          |
| 4       |                                                                                               | 4                          |
| 5       |            | 1                          |
| 6       |                                                                                                | 4                          |
| 7       |                                                                                                | 8                          |
| 8       |                                                                                                | 7*10ft: 72<br>8*12ft: 76+4 |
| 9       |                                                                                                | 1                          |

PART NO QTY

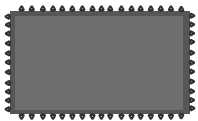
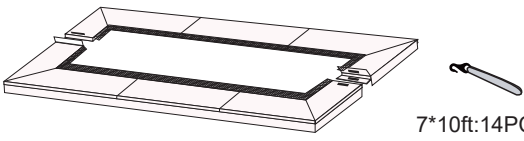
|    |                                                                                                                         |   |
|----|-------------------------------------------------------------------------------------------------------------------------|---|
| 10 |  <p>7*10ft:14PCS<br/>8*12ft:24PCS</p> | 1 |
|----|-------------------------------------------------------------------------------------------------------------------------|---|

|    |                                                                                   |   |
|----|-----------------------------------------------------------------------------------|---|
| 11 |  | 1 |
|----|-----------------------------------------------------------------------------------|---|

|    |                                                                                    |    |
|----|------------------------------------------------------------------------------------|----|
| 12 |  | 16 |
|----|------------------------------------------------------------------------------------|----|

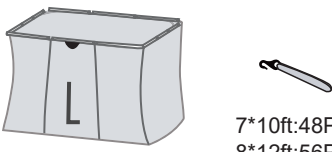
|    |                                                                                                                          |   |
|----|--------------------------------------------------------------------------------------------------------------------------|---|
| 13 |  <p>7*10ft:48PCS<br/>8*12ft:56PCS</p> | 1 |
|----|--------------------------------------------------------------------------------------------------------------------------|---|

|    |                                                                                     |   |
|----|-------------------------------------------------------------------------------------|---|
| 14 |  | 8 |
|----|-------------------------------------------------------------------------------------|---|

|    |                                                                                     |   |
|----|-------------------------------------------------------------------------------------|---|
| 15 |  | 4 |
|----|-------------------------------------------------------------------------------------|---|

|    |                                                                                     |   |
|----|-------------------------------------------------------------------------------------|---|
| 16 |  | 4 |
|----|-------------------------------------------------------------------------------------|---|

|    |                                                                                     |   |
|----|-------------------------------------------------------------------------------------|---|
| 17 |  | 8 |
|----|-------------------------------------------------------------------------------------|---|

PART NO

QTY

18

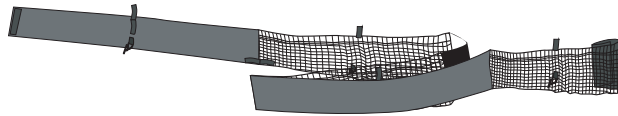

1

19



4

20

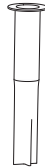

4

21



4

Assembly Tip

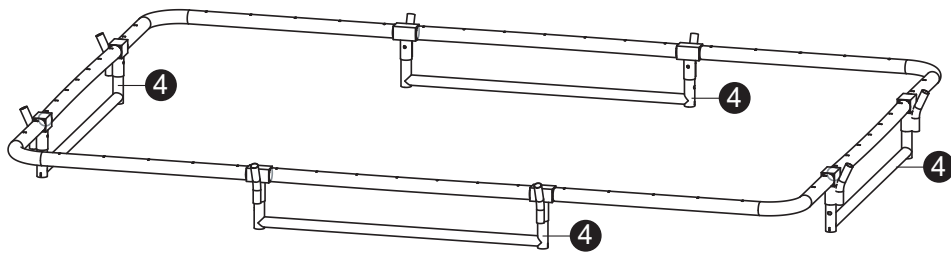
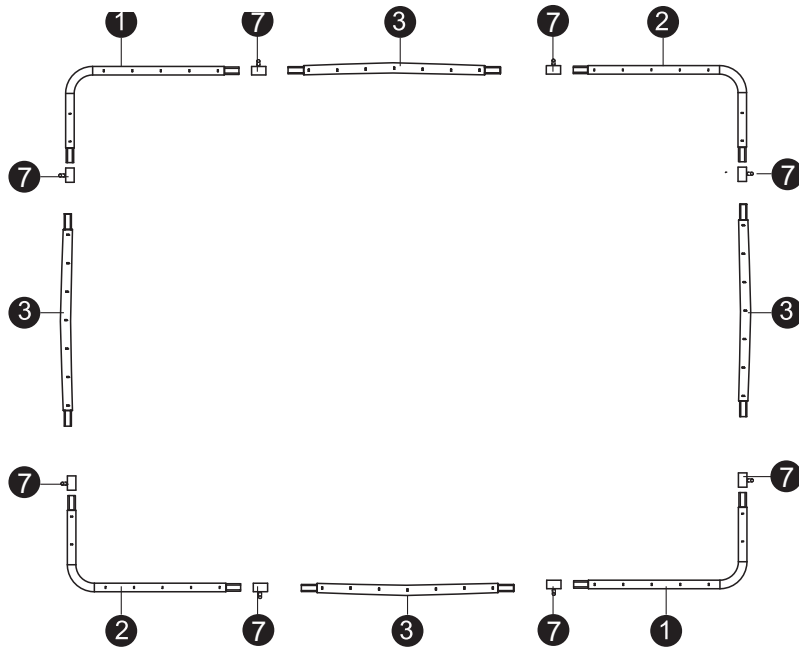

1

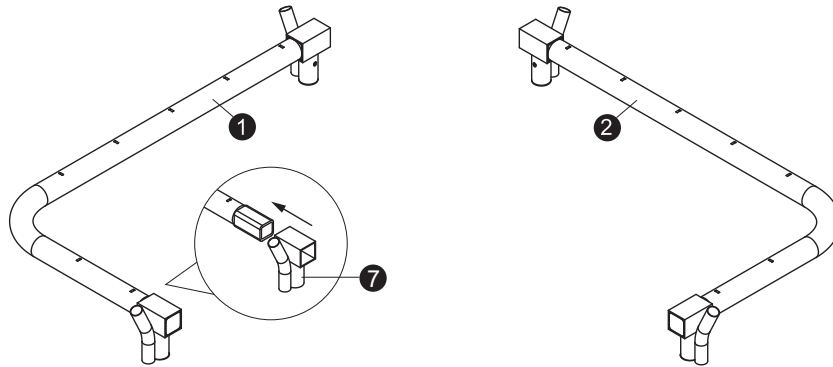

2

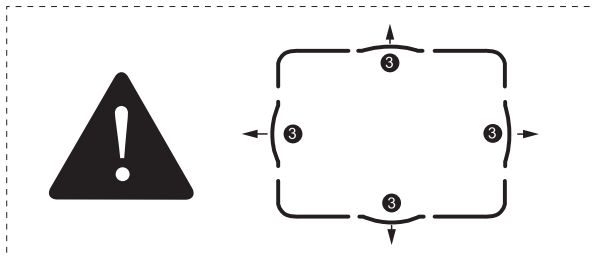
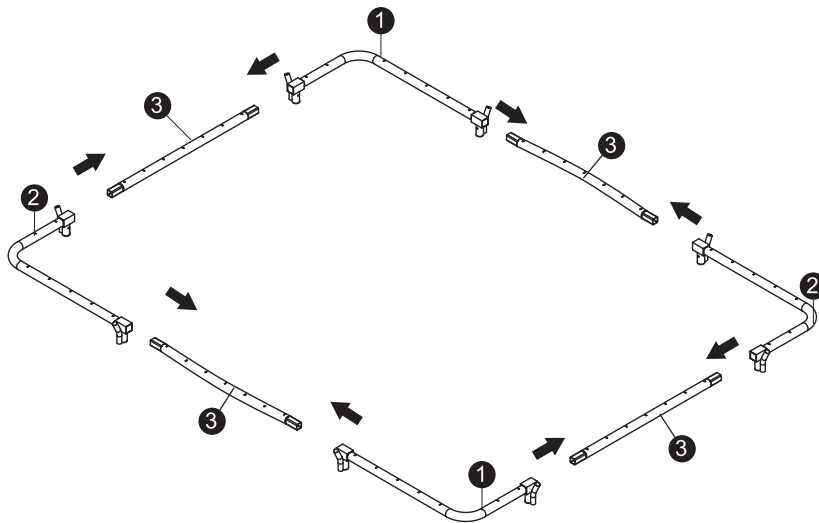

3

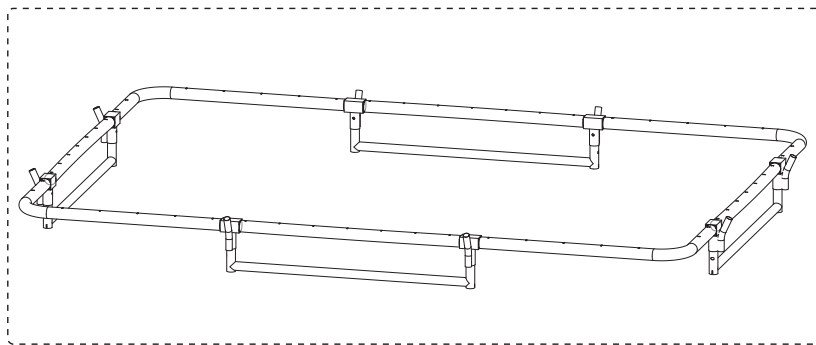
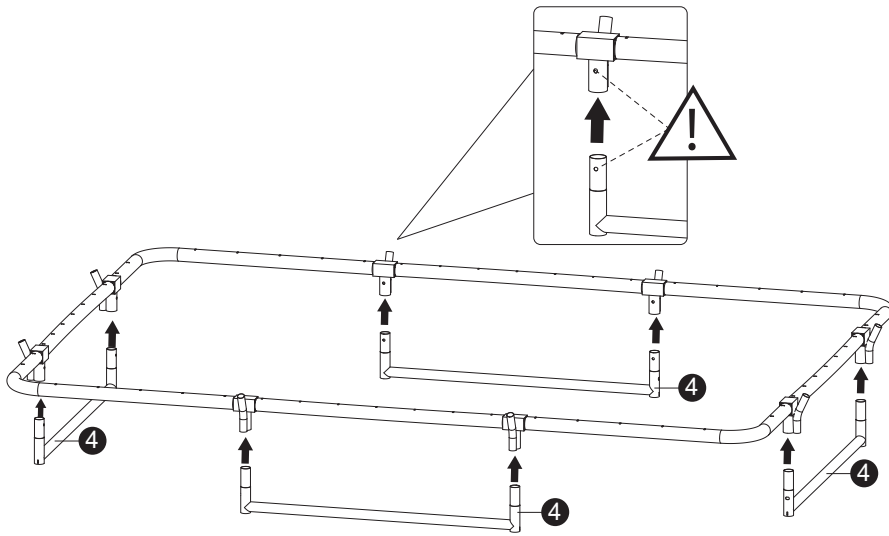

4

1

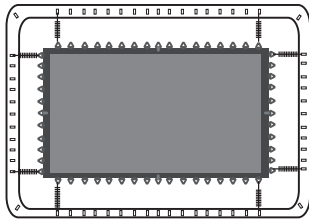

2

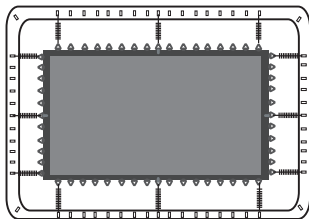

3

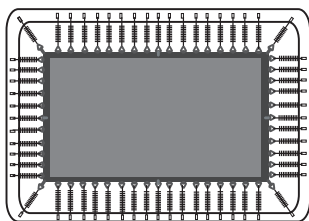

7x10ft trampoline

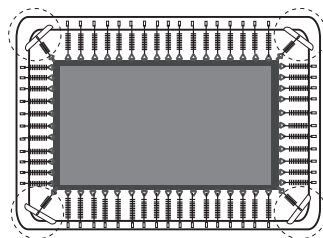

8x12ft trampoline

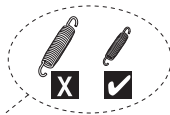
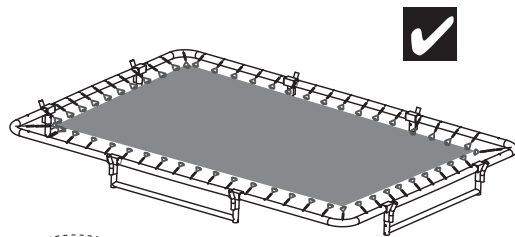
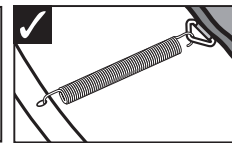
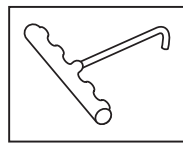
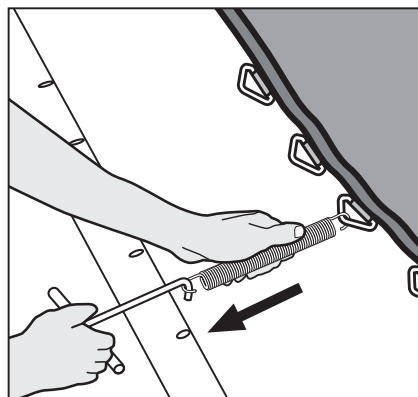

5

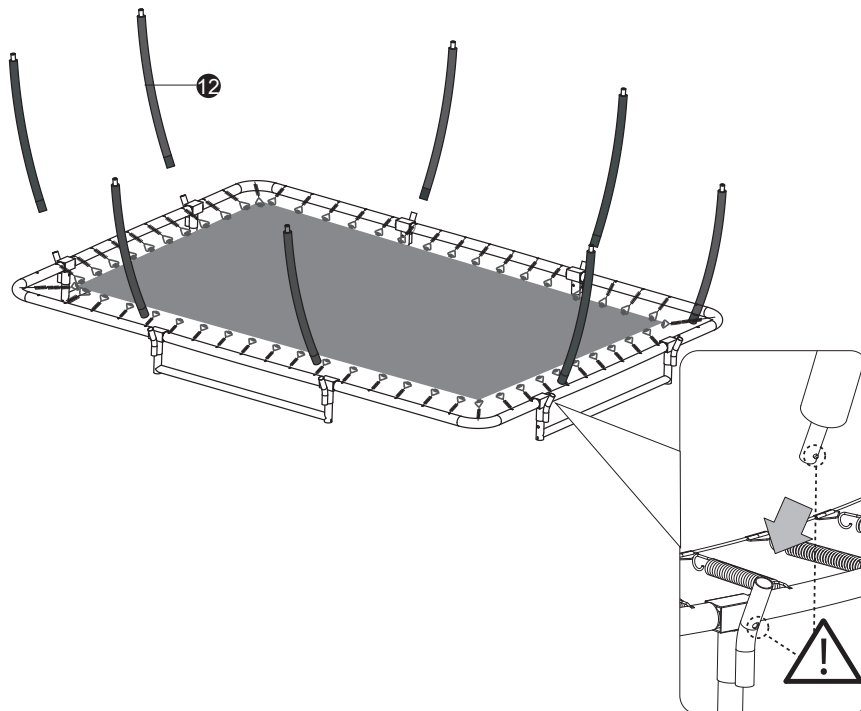



6

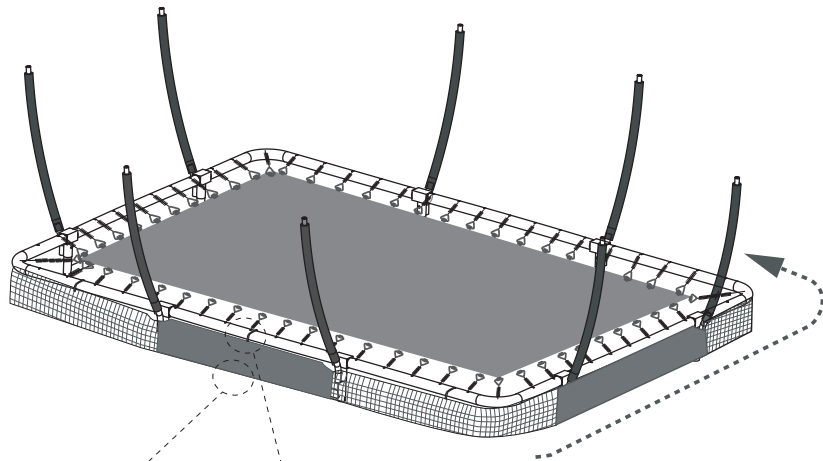

1

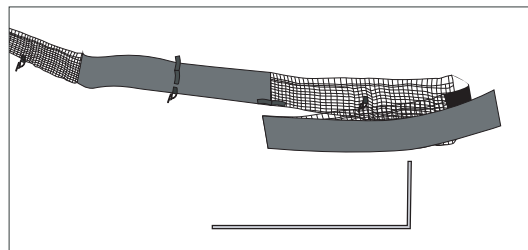
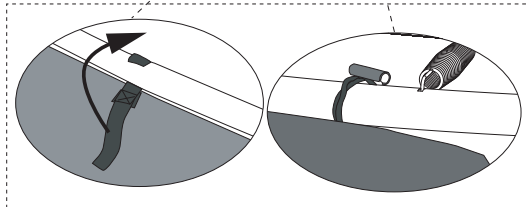

2

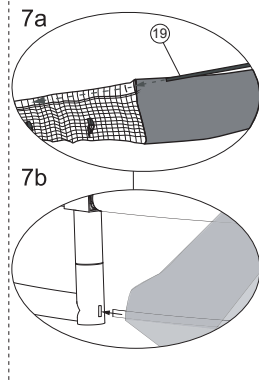

7

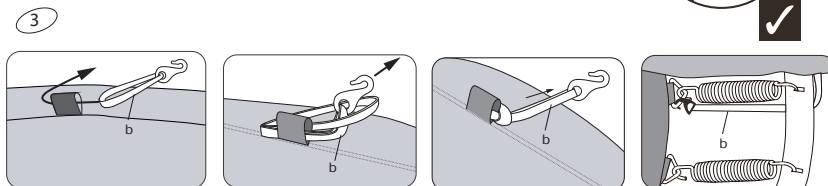
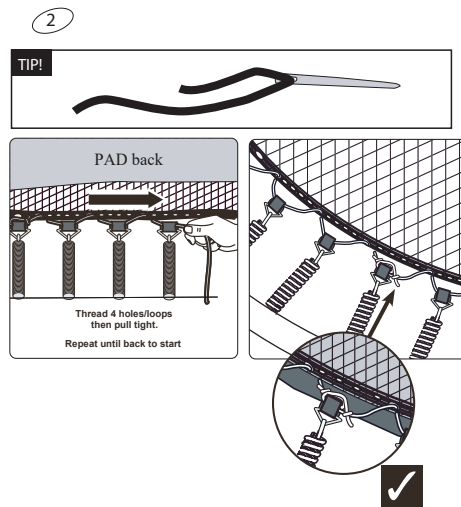
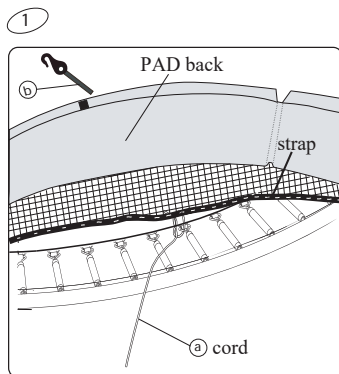
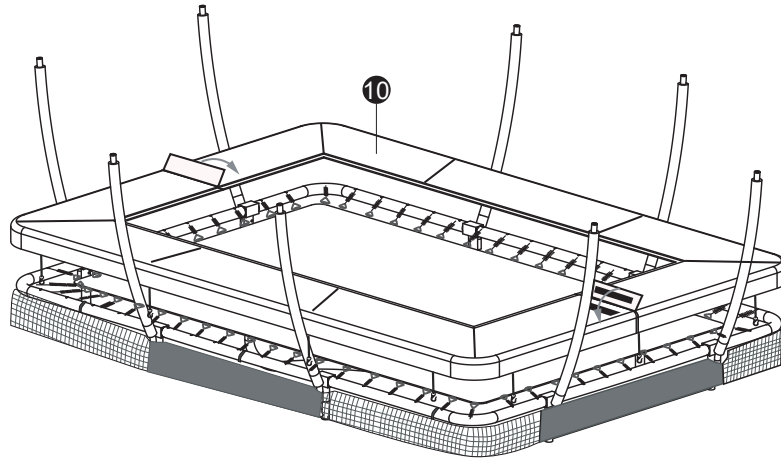

8

Assembly Tip

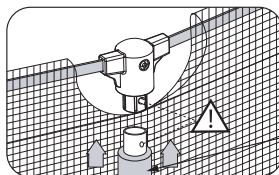
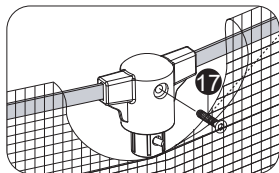
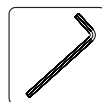
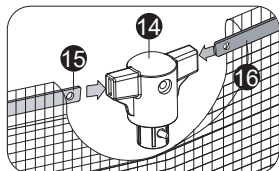
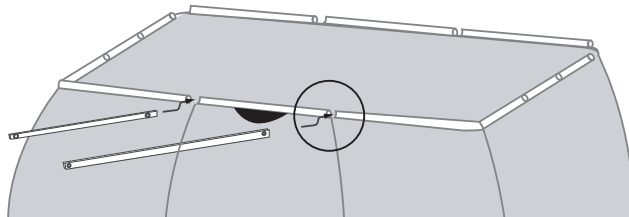
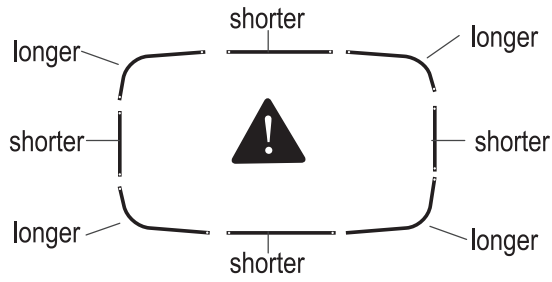

9

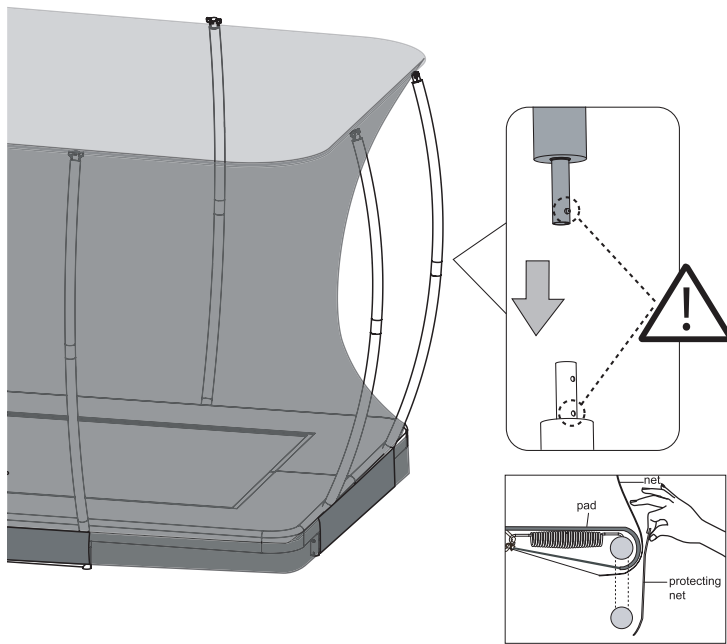

- 1
- 2
- 3
- 4
- 5
- 6

10

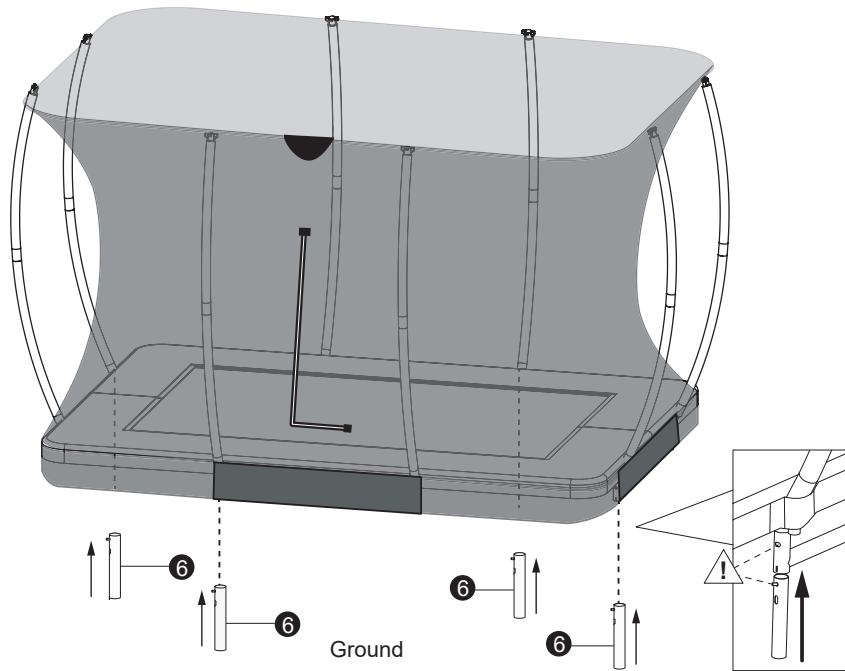

11

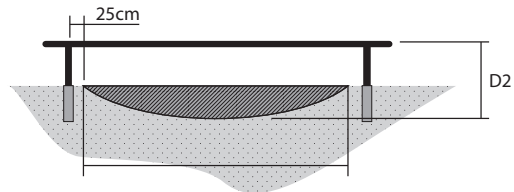

|                   | PIT       | D2         |
|-------------------|-----------|------------|
| 7x10ft(215*305cm) | 163x255cm | min. 95cm  |
| 8x12ft(244*365cm) | 194x315cm | min. 100cm |

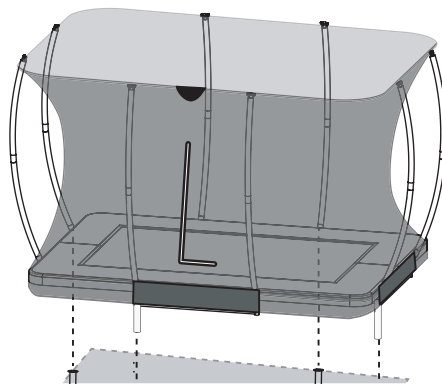
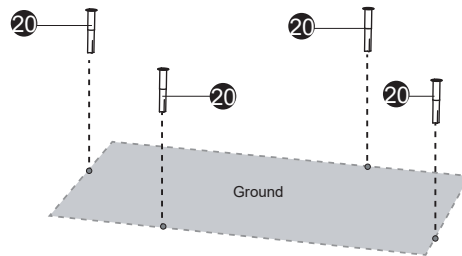
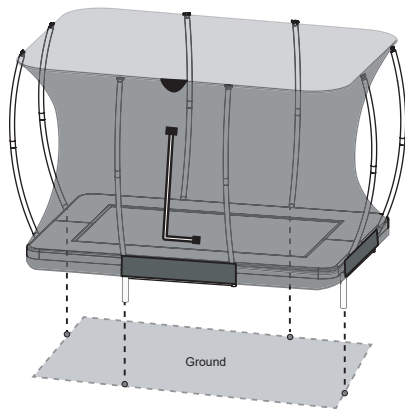

12

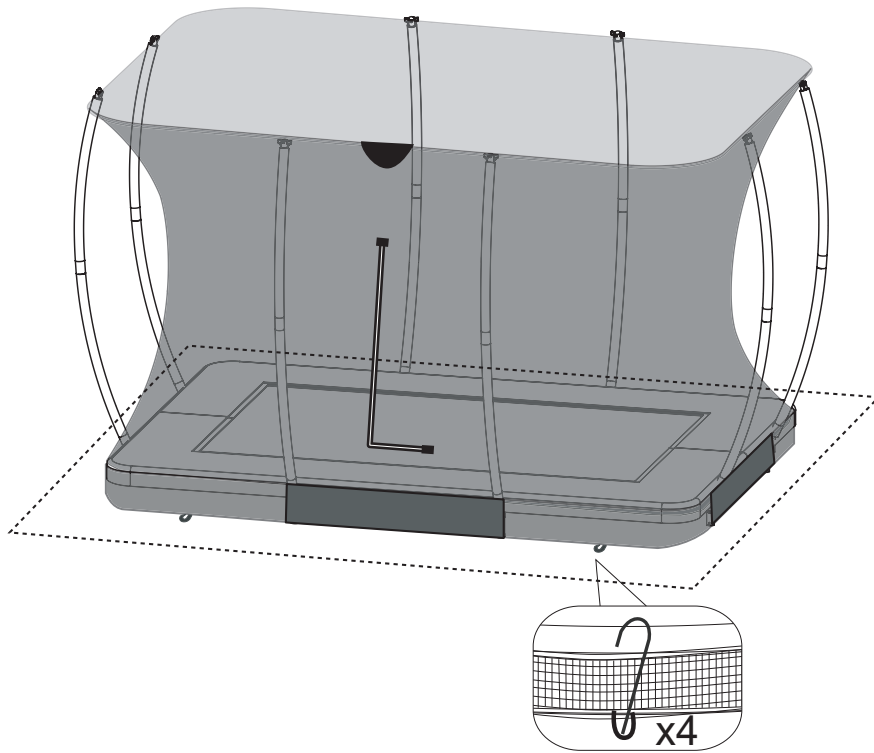

Congratulations! Your trampoline is now fully assembled (put together).

Herzlichen Glückwunsch! Ihr Trampolin ist nun montiert und bereit zum Gebrauch.

Gefeliciteerd! De trampoline is nu volledig gemonteerd (in elkaar gezet).

Félicitations ! Votre trampoline est maintenant entièrement assemblé (remonté).

Tillykke! Din trampolin er nu fuldt monteret (sat sammen).